



库威得
KUDOSWORLD



PERMANENT MAGNETIC COUPLING

PMCO-N
KWN 29020



**Product | Engineering Services
Maintenance**





**PERMANENT MAGNETIC
COUPLING**

**PMCO-N
KWN 29020**

Technical Informations

The permanent magnet coupling is a device which transmits the torque from the motor to the load through the air gap between the conductor and the permanent magnet. It can realize the transmission mode without mechanical connection between motor and load.

The working principle is that when the conductor and permanent magnet move relative to each other, the conductor assembly cuts the magnetic line of force and generates eddy current in the conductor, which in turn generates an anti induction magnetic field around the conductor disc and prevents the relative movement of the conductor disc and the magnet disc, so as to realize torque transmission.

Technical Features

1. Remarkable energy saving effect.
2. Flexible start, reduce the impact current of the motor, extend the service life of the equipment.
3. Improve the starting ability of the motor, reduce the impact and vibration, and coordinate the load distribution of multi machine drive.
4. Simple structure, small volume and convenient installation. The maintenance cost is very low to adapt to all kinds of harsh environment.
5. Large installation centering error is allowed, which greatly simplifies the installation and debugging process
6. Friendly to environment, no pollutants and harmonics.
7. With automatic reset function.
8. It has the function of overload protection, which improves the reliability of the whole system and completely eliminates the damage caused by overload.
9. According to the operating conditions, the permanent magnet can be selected as 120 °C and 180 °C.

Applications

It is suitable for equipment requiring soft start, unstable load and overload protection. Such as elevator, crusher, belt conveyor, bucket wheel machine, leather machine, mixer, etc

Designation

PMCO – N – LMC 540

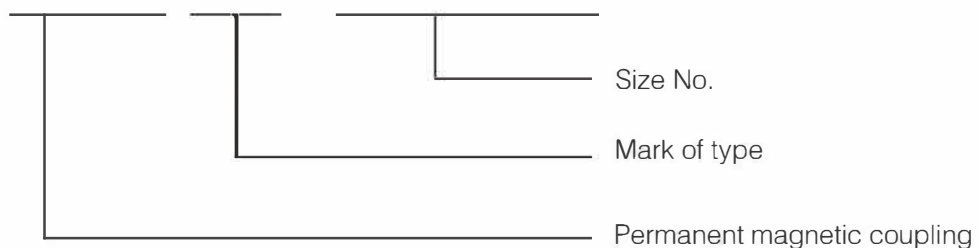

MCB Standard Permanent Magnet Coupling

The standard permanent magnet coupling is generally composed of two parts: permanent magnet rotor and conductor rotor. Generally, the conductor rotor (steel rotor with copper ring) is connected with the motor shaft, and the permanent magnet rotor (aluminum rotor with permanent magnet material) is connected with the working machine shaft. There is a fixed air gap between the permanent magnet rotor and the conductor rotor, and there is no mechanical connection for transmitting torque. When the motor is rotating, induced eddy current is generated when cutting the magnetic field line of permanent magnet on the copper ring of conductor rotor, and the force between the magnetic field of induced eddy current and the magnetic field of permanent magnet realizes the torque transfer between the motor and the working machine. The air gap can be adjusted within a certain range to meet the required torque transmission and speed requirements.

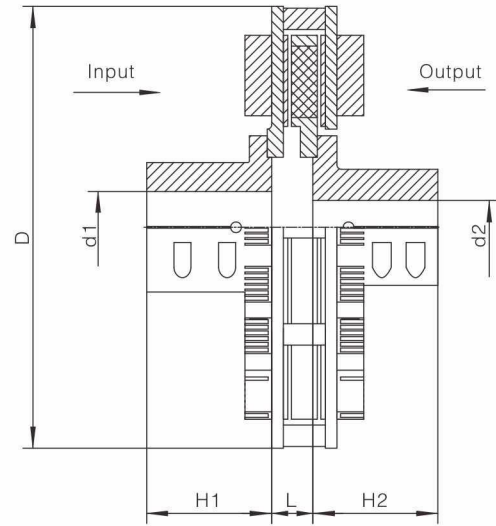

Applications

- It is suitable for difficult centering equipment;
- Suitable for long-term stable operation, relatively stable load is not easy to block the rotating equipment.
For example: water pump, fan, etc

Main Dimensions / Characteristic Values

Size	Main dimensions		Applicable power range (kw)		
	D(mm)	L(mm)	1500r/min	1000r/min	750r/min
MCB 320	385	46	7.5-11	---	---
MCB 340	405	46	15-22	11	7.5
MCB 360	425	46	30-37	18.5-22	15-18.5
MCB 380	445	46	45-55	30-37	22-30
MCB 430	495	46	75-90	45-55	37-45
MCB 470	535	46	110-132	75-90	55
MCB 500	565	46	160-185	110	75-90
MCB 540	605	46	200-220	132	110
MCB 580	645	46	250-280	160-185	132
MCB 600	665	50	315	200	160
MCB 610	670	50	355-400	220-250	185-200
MCB 630	690	50	450-500	300-315	220-250
MCB 685	750	52	560-630	355-400	280-315
MCB 735	800	52	710-800	450-560	355-400
MCB 770	835	52	900-1000	630-710	450-500

LMC Limited Moment Permanent Magnet Coupling

There is a variable air gap between the permanent magnet rotor and the conductor rotor in the limited moment type permanent magnet coupling. When the driving machine drives the conductor rotor to rotate, it makes a circular motion of cutting magnetic force line relative to the permanent magnet installed at the driven end, so that the conductor rotor at the active end produces eddy current magnetic field, and interacts with the permanent magnet magnetic field at the driven end, so as to realize no contact between the active end and the driven end Torque transfer;

When the working machine is under rated load, the air gap between the permanent magnet rotor and the conductor rotor is the smallest;

When the machine is overloaded or jammed, the air gap between the permanent magnet rotor and the conductor rotor increases rapidly until the maximum air gap, and the speed of the permanent magnet rotor at the machine end drops until it stops rotating, so as to realize the overload protection of the motor.

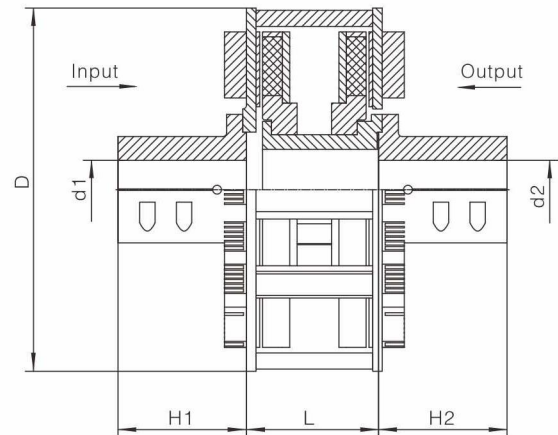

Applications

- It is suitable for on-site equipment with large axial displacement;
- It is suitable for equipment requiring soft start, unstable load and overload protection. For example: elevator, crusher, belt conveyor, bucket wheel, etc.

Main Dimensions / Characteristic Values

Size	Main dimensions		Applicable power range (kw)		
	D(mm)	L(mm)	1500r/min	1000r/min	750r/min
LMC 320	385	180	7.5-11	---	---
LMC 340	405	180	15-22	11	7.5
LMC 360	425	180	30-37	18.5-22	15-18.5
LMC 380	445	180	45-55	30-37	22-30
LMC 430	495	180	75-90	45-55	37-45
LMC 470	535	180	110-132	75-90	55
LMC 500	565	180	160-185	110	75-90
LMC 540	605	195	200-220	132	110
LMC 580	645	195	250-280	160-185	132
LMC 600	665	215	315	200	160
LMC 610	670	215	355-400	220-250	185-200
LMC 630	690	215	450-500	300-315	220-250
LMC 685	750	230	560-630	355-400	280-315
LMC 735	800	230	710-800	450-560	355-400
LMC 770	835	230	900-1000	630-710	450-500

LMCP Limited Torque Brake Wheel Type Permanent Magnet Coupling

The limited torque permanent magnet coupling is composed of permanent magnet rotor, conductor rotor and brake wheel. The combination of permanent magnet coupling and brake wheel shortens the length of transmission chain and can drive and brake. Its principle and performance are basically the same as LMC limited torque permanent magnet coupling.

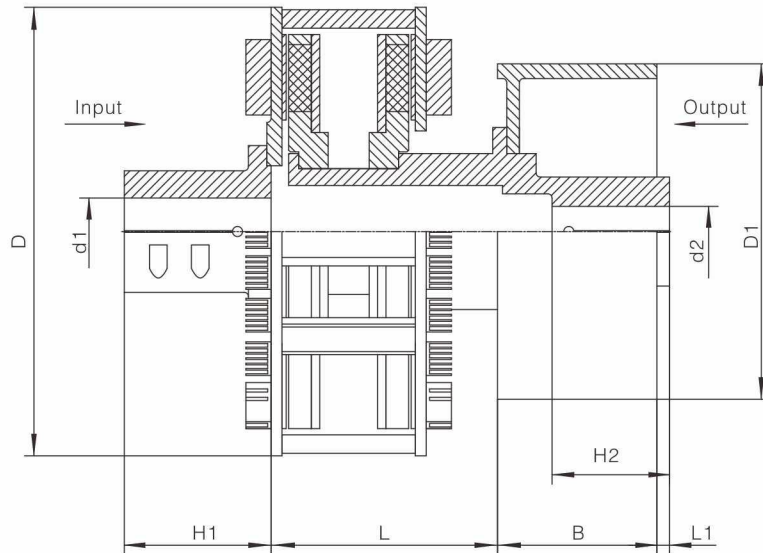

Applications

It is suitable for equipment requiring soft start, unstable load and overload protection and braking. For example: belt conveyor, etc.

Main Dimensions / Characteristic Values

Size	Main dimensions					Applicable power range (kw)		
	D	D1	L	B	L1	1500r/min	1000r/min	750r/min
LMCP 360	425	315	245	150	10	30-37	18.5-22	15-18.5
LMCP 380	445	315	245	150	10	45-55	30-37	22-30
LMCP 430	495	315	245	150	10	75-90	45-55	37-45
LMCP 470	535	400	245	190	15	110-132	75-90	55
LMCP 500	565	400	245	190	15	160-185	110	75-90
LMCP 540	605	400	260	190	15	200-220	132	110
LMCP 580	645	500	260	210	15	250-280	160-185	132
LMCP 600	665	500	280	210	15	315	200	160
LMCP 610	670	500	280	210	15	355-400	220-250	185-200
LMCP 630	690	630	280	265	15	450	300	220
LMCP 685	750	630	300	265	15	560-630	355-400	280-315
LMCP 735	800	630	300	265	15	710-800	450-560	355-400

LMCK Limited Torque Belt Wheel Type Permanent Magnet Coupling

The limited torque permanent magnet coupling with belt pulley is composed of permanent magnet rotor, conductor rotor and belt pulley. The input and output are at the same end, which are used in parallel transmission mechanical equipment. Its principle and performance are basically the same as LMC limited torque permanent magnet coupling.

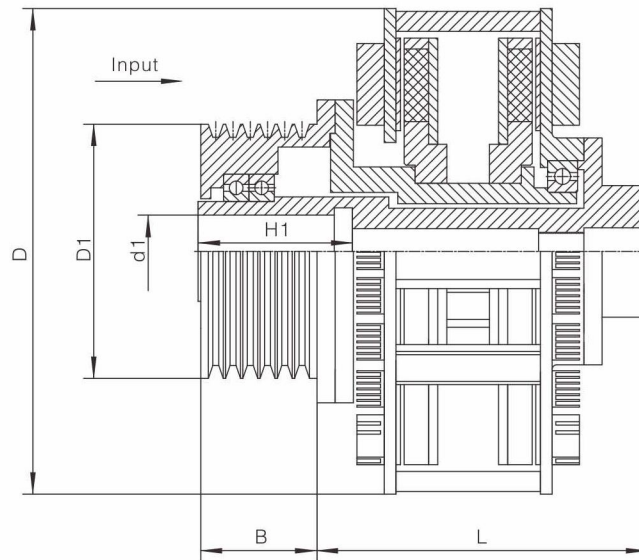

Applications

The input and output of this structure are at the same end, which is suitable for equipment requiring soft start, unstable load and overload protection, such as: leather machine, mixing machine, etc.

Main dimensions / Characteristic values

Size	Main dimensions		Applicable power range (kw)		
	D (mm)	L(mm)	1500r/min	1000r/min	750r/min
LMCK 360	425	335	30-37	18.5-22	15-18.5
LMCK 380	445	335	45-55	30-37	22-30
LMCK 430	495	365	75-90	45-55	37-45
LMCK 470	535	365	110-132	75-90	55
LMCK 500	565	365	160-185	110	75-90
LMCK 540	605	385	200-220	132	110
LMCK 580	645	385	250-280	160-185	132
LMCK 600	665	425	315	200	160
LMCK 610	670	425	355-400	220-250	185-200

LMC-SC Limited Torque And Non-Completely Closed Type

The limited moment non – completely closed permanent magnet coupling is composed of three parts: permanent magnet rotor, conductor rotor and closed chamber. The permanent magnet rotor and conductor rotor are in a relatively closed space to prevent the contact of impurities and prolong the service life of the permanent magnet coupling. Its principle and performance are basically the same as that of LMC.

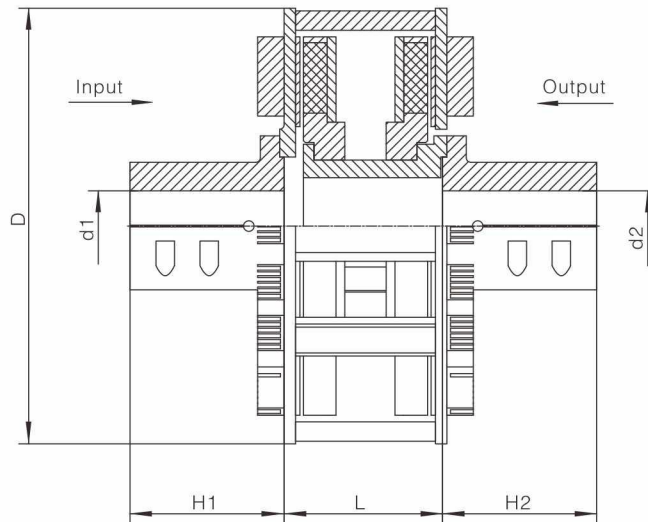

Applications

This kind of structure has certain sealing property, suitable for the environment is poor place. Equipment requiring overload protection. For example: steel mills, mines, etc.

Main Dimensions / Characteristic Values

Size	Main dimensions		Applicable power range (kw)		
	D (mm)	L(mm)	1500r/min	1000r/min	750r/min
LMC-SC 320	385	180	7.5-11	---	---
LMC-SC 340	405	180	15-22	11	7.5
LMC-SC 360	425	180	30-37	18.5-22	15-18.5
LMC-SC 380	445	180	45-55	30-37	22-30
LMC-SC 430	495	180	75-90	45-55	37-45
LMC-SC 470	535	180	110-132	75-90	55
LMC-SC 500	565	180	160-185	110	75-90
LMC-SC 540	605	195	200-220	132	110
LMC-SC 580	645	195	250-280	160-185	132
LMC-SC 600	665	215	315	200	160
LMC-SC 610	670	215	355-400	220-250	185-200
LMC-SC 630	690	215	450-500	300-315	220-250
LMC-SC 685	750	230	560-630	355-400	280-315
LMC-SC 735	800	230	710-800	450-560	355-400
LMC-SC 770	835	230	900-1000	630-710	450-500

LMC-TC Limited Torque and Completely Closed Type

The limited moment totally enclosed permanent magnet coupling is composed of permanent magnet rotor, conductor rotor and closed chamber. The permanent magnet rotor and conductor rotor of this kind of permanent magnet coupling are completely enclosed in a space to prevent impurities from contacting with them and extend the service life of the permanent magnet coupling. Its principle and performance are basically the same as that of LMC.

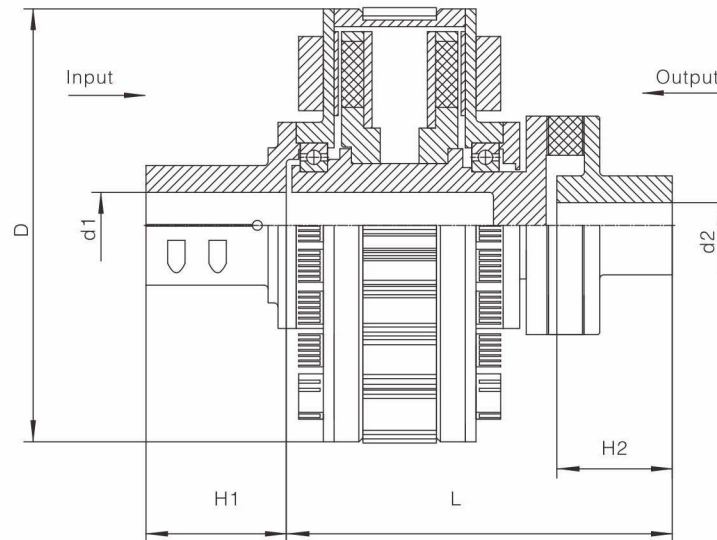

Applications

It is suitable for all kinds of bad working conditions, which need soft start, unstable load and overload protection. For example: elevator, crusher, belt conveyor, bucket wheel, etc.

Main Dimensions / Characteristic Values

Size	Main dimensions		Applicable power range (kw)		
	D (mm)	L(mm)	1500r/min	1000r/min	750r/min
LMC-TC 360	415	440	30-37	18.5-22	15-18.5
LMC-TC 380	435	440	45-55	30-37	22-30
LMC-TC 430	485	465	75-90	45-55	37-45
LMC-TC 470	525	465	110-132	75-90	55
LMC-TC 500	555	465	160-185	110	75-90
LMC-TC 540	595	525	200-220	132	110
LMC-TC 580	635	525	250-280	160-185	132
LMC-TC 600	655	570/610	315	200	160
LMC-TC 610	660	570/610	355-400	220-250	185-200
LMC-TC 630	680	570/610	450	300	220



**PERMANENT MAGNETIC
COUPLING**

**PMCO-N
KWN 29020**



库威得
KUDOSWORLD



SHENYANG KUDOSWORLD TECHNOLOGY CO., LTD

Add: Orchard Summer Palace, No.209-2 Qingnian Street, Shenhe

District, Shenyang City, China 110016

Tel: 0086 (024) 31976438

Fax: 0086(024) 3197 6437